

Keston

BY IDEAL HEATING

KESTON COMBI 2

30kW & 35kW Output Combi Boiler



Easy to service



Twin Flue up to 27m*



Weather compensator



Compact cupboard fit



Frost protection



Large high resolution colour screen



Halo Combi compatible



Low component count maximising reliability

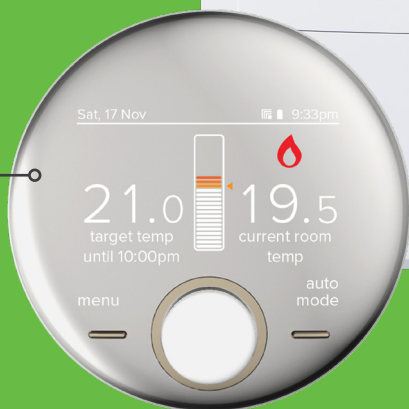

Features & specification

Offering first-class comfort in a compact, wall-hung appliance small enough to fit inside a standard kitchen cupboard*, the Keston Combi 2 range enables heating and hot water to be controlled independently, ensuring maximum comfort and efficiency.

Keston Combi 2 can be sited almost anywhere in the home, without the need for a separate tank. And because it connects to the unique Keston Twin Flue system, the boiler can be situated anywhere up to 27** metres from the flue outlet, helping to provide further flexibility when required.

Fully modulating, and with weather compensation, Keston Combi 2 provides excellent energy savings, making it the perfect choice for new or replacement installations alike.

THE FACTS

- 7 year warranty†
- Easy to see pressure gauge
- Large backlit display with user friendly controls
- Low lift weight
- Low component count maximising reliability
- Compact dimensions
- Twin flue up to 27m**
- 50mm muPVC (PVC-C) solvent weld flue allowing simple, cost effective installations***
- Weather compensator supplied as standard making Keston Combi 2 **Boiler Plus compliant out of the box**
- Pre-fitted filling loop
- Inbuilt frost protection
- Fully modulating
- LPG conversion kit available

DIMENSION & CLEARANCES

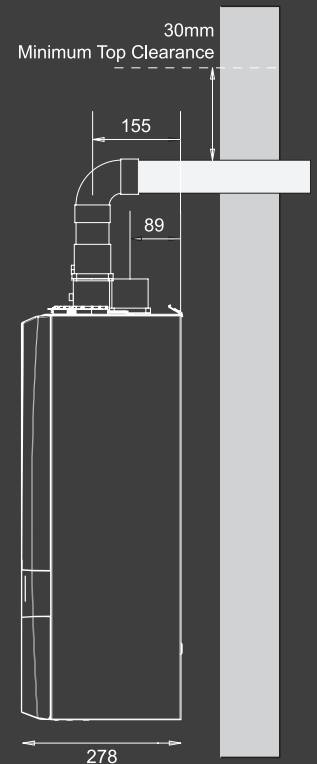
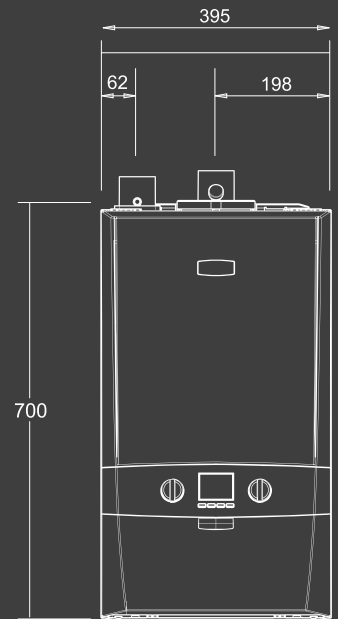

† 7 year warranty when installed with a Keston 22mm System Filter and registered within 30 days of installation. 5 year parts & labour warranty as standard. Terms and conditions apply.* Please check cupboard size prior to installation.** For the maximum total equivalent flue length, please refer to the installation manual.*** The only systems approved for this application are: Marley muPVC (PVC-C) Solvent Weld Waste System (50mm), Polypipe System 2000 muPVC (PVC-C) Solvent Weld Waste System (50mm), Polypipe Terrain Solvent Weld System (50mm) and Wavin Osmo PVC-C Solvent Weld System (50mm). Please use the recommended Solvent Weld Cement for each system.

Specification Data

CENTRAL HEATING			C30	C35
CH Output @ 70°C	Max	kW	24.2	24.2
	Min	kW	6.1	7.1
CH Output @ 40°C	Max	kW	25.6	25.6
	Min	kW	6.4	7.5
CH Input	Nett CV Max	kW	24.3	24.3
	Nett CV Min	kW	6.1	7.1
CH Input	Gross CV Max	kW	27.0	27.0
	Gross CV Min	kW	6.7	7.9
CH Gas Consumption	Max	m ³ /h	2.512	2.512
	Min	m ³ /h	0.627	0.734
HOT WATER			C30	C35
DHW Output	Max	kW	30.3	35.3
DHW Input	Nett CV Max	kW	30.4	35.4
DHW Input	Gross CV Max	kW	33.7	39.3
DHW Gas Consumption		m ³ /h	3.135	3.657
DHW Flow Rate at 35°C Rise		l/min	12.4	14.5
DHW Specific Rate		l/min	14.5	16.9
OTHERS			C30	C35
Seasonal Efficiency	SEDBUK 2005	%	91.1	91.1
	SEDBUK 2009/2012	%	89.6	89.6
Seasonal Space Heating Efficiency Class			A	A
NOx Classification			Class 6	Class 6
GENERAL DATA			C30	C35
Max Horizontal Flue Length		m	27 Flue / 2 Air	25 Flue / 2 Air
Max Horizontal Flue Length (Parallel)		m	18 Flue / 18 Air	15 Flue / 15 Air
Flue Terminal Diameter		mm	50	
Gas Supply			2H - G20 - 20mbar	
Gas Supply Connection			15mm copper compression	
Injector Size		mm	4.65	4.90
Flow Connection (CH)			22mm copper compression	
Return Connection (CH)			22mm copper compression	
Inlet Connection (DHW)			15mm copper compression	
Outlet Connection (DHW)			15mm copper compression	
Average Flue Temp - Mass Flow Rate (DHW)			68°C - 13g/s	73°C - 15g/s
CO ₂ Content (±0.7) (Min CH)		%	8.5	8.8
CO ₂ Content (±0.7) (Max DHW)		%	9.3	9.7
Max Working Pressure (Sealed Systems)		bar (psi)	2.5 (36.3)	
Max DHW Inlet Pressure		bar (psi) (kPa)	10.0 (145) (1000)	
Min DHW Inlet Pressure		bar (psi) (kPa)	1.3 (18.9) (130)	
Electrical Supply			230V - 50Hz	
Power Consumption		W	93	110
Fuse Rating			External 3A / Internal: T4A HRC L250V	
Water Content (CH)		l (gal)	1.2 (0.26)	
Water Content (DHW)		l (gal)	1.0 (0.22)	
Weight (Packed)		kg	32.9	32.9
Maximum Installation Weight		kg	28.6	28.6

Example Flue Installation

Keston Combi 2 C30 - Flue & Air Pipe Length

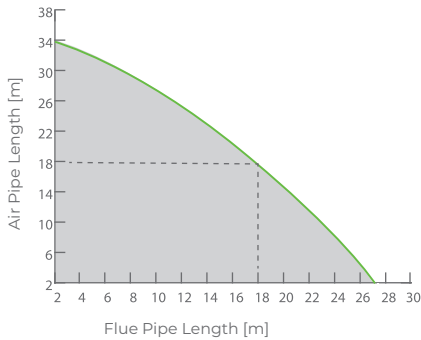

acceptable flue operating area

Graph indicates maximum flue run 27m with 2m air. Also, 18m flue with 18m air pipe for parallel twin flue run.

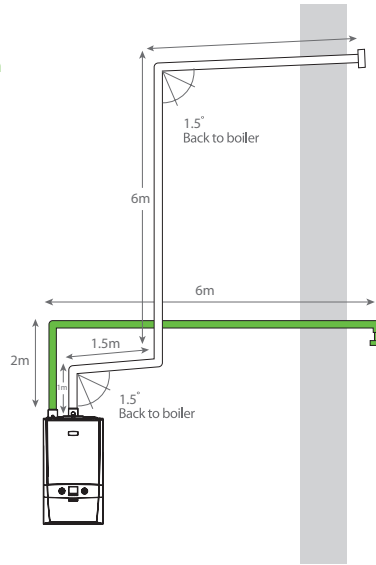

C53 HORIZONTAL

Calculations

Flue
Elbows 3 x 1m = 3m
Straights 4+6+1.5+1 = 12.5m
Total = 15.5m

Air
Elbows 2 x 1m = 2m
Straights 6+2+0.1+1 = 8.1m
Total = 10.1m

Keston Combi 2 C35 - Flue & Air Pipe Length

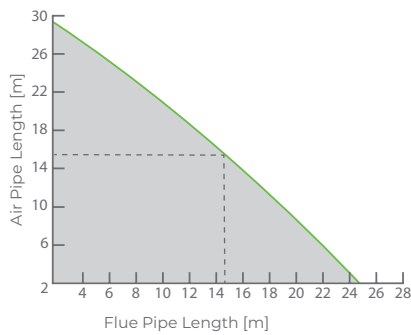

acceptable flue operating area

Graph indicates maximum flue run 25m with 2m air. Also, 15m flue with 15m air pipe for parallel twin flue run.

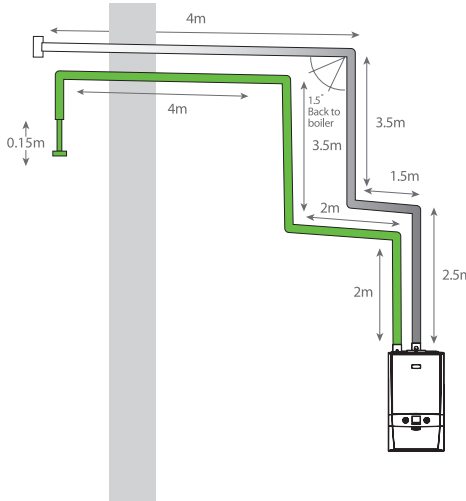

C13 HORIZONTAL

Calculations

Flue
Elbows 3 x 1m = 3m
Straights 4+3.5+1.5+2.5 = 11.5m
Total = 14.5m

Air
Elbows 4 x 1m = 4m
Straights 2+2+3.5+4+0.15 = 11.65m
Total = 15.65m

Dimensions

KESTON COMBI 2

Height 700mm

Width 395mm

Depth 278mm

The following minimum clearances must be maintained for operation and servicing.

Front of boiler - 450mm[†]

Sides of boiler - 2.5mm

Above boiler - 350mm, with 30mm above the flue

Below boiler - 100mm[†]

* Or equivalent length.

† Can be reduced to 5mm for cupboard fit, 450mm required for servicing.

Tel: 01482 443 005 Fax: 01482 467 133

Keston Heating, PO Box 103, National Avenue, Kingston Upon Hull HU5 4JN

keston.co.uk |     

**EXPERTS IN
HEATING**